

Varenummer: 40550501291220  
 Beskrivelse: Tandhjulsgear S501P-12,9-P63B5

## Mål

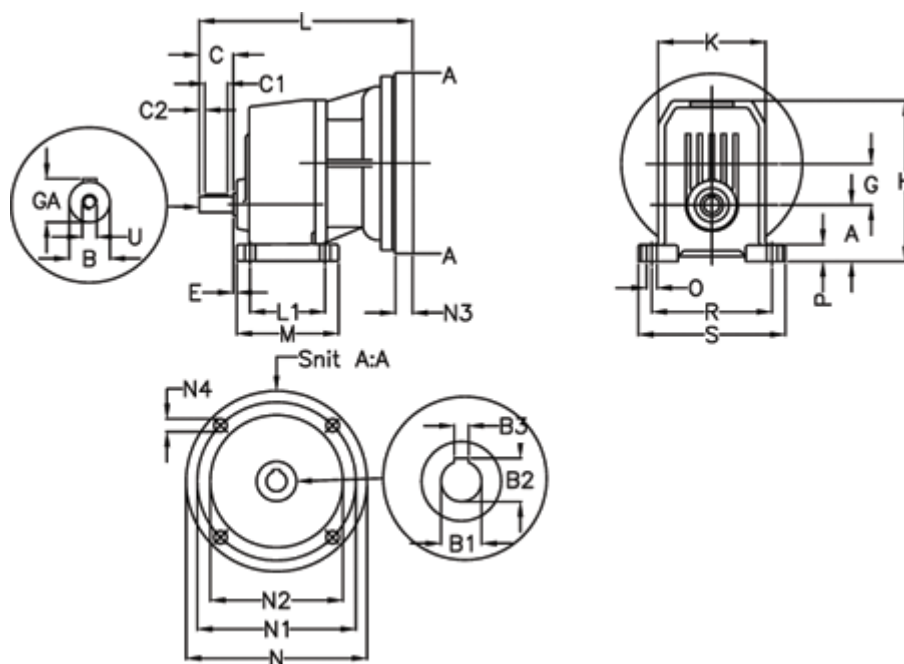

A = 82	E = 25.5	M = 190.0	R = 225
B = 38	F = 10x8x60	N = 140	S = 270
B1 = 11	G = 73.5	N1 = 115	U = M12
B2 = 16.3	GA = 41.0	N2 = 95	
B3 = 4	H = 278.5	N3 = -	
C = 80	K = 185	N4 = M8x16	
C1 = 60	L = 314	O = 18	
C2 = 10	L1 = 145.0	P = 25.0	